

TROUBLE SHOOTING

Symptom	Possible Cause	Remedy
The hot or cold water is very slow to turn on	Pinched tubing	Check control tubing (yellow and blue lines)
The hot or cold water is very slow to shutoff or will not shutoff	Pinched tubing	Check control tubing (green and blue)
Noise from the Valve Blocks while the water is running	The Valve Block may have excessive debris trapped under the Filter-screen	Service the Valve Blocks
Noise from the Valve Blocks when turning water on and off	Air in the system	Operate the pedal on and off rapidly to clear air from the valves.

For further information: www.tapmaster.ca or call 800-791-8117

FIVE YEAR LIMITED WARRANTY

Congratulations on your purchase of TAPMASTER Hands Free Faucet Controller!

TAPMASTER products are thoroughly tested before shipment and are warranted to be free of defects in material and workmanship for five years from the date of original purchase. The sole obligation of Tapmaster Incorporated under the warranty is to provide replacement parts or at its option to repair the defective product or to provide the replacement product. Replacement parts furnished in fulfillment of this warranty are warranted only for the unused portion of the original warranty. Labor and shipping charges are not included.

Warranty conditions - The five year warranty is subject to exclusions and limitations as stated below:

Warranty extends only to defects which occur during normal use and intended applications and does not extend to damage to products or parts resulting from alteration, repair, modification or faulty installation. This warranty does not cover damage resulting from water borne debris or from media other than clean potable water. Tapmaster Incorporated makes no other express warranty on this product, all implied warranties including any implied warranty of merchantability and fitness for a particular purpose are hereby disclaimed and excluded. In no event shall Tapmaster Incorporated be liable for special, incidental or consequential damages resulting from the use of this product or arising from breach of warranty or contract, negligence, loss of time, inconvenience or loss of use of equipment.

Tapmaster Incorporated
3-1470 28th Street NE
Calgary, AB Canada
T2A 7W6

Rev 3.0

-4-

PH: 800-791-8117
FAX: 403-275-5928
Web: www.tapmaster.ca
E-mail: info@tapmaster.ca



CSA-B125.1-18
ASME A112.18.1-2018
NFS/ANSI 61-2016
NFS/ANSI 372-2016



PATENT NUMBERS
U.S. 5,505,227, 6,254,057,
6,382,585
Canadian 2,109,684
European 0654628
International & Other Patents
Pending

INSTALLATION INSTRUCTIONS: EURO Models 1770, 1771, 1775 & 1776

CAUTION - READ BEFORE INSTALLATION

Tapmaster Incorporated will not be held liable for damage to property or persons resulting from improper installation of this product. If you are uncertain about any part of the installation process, please contact us for assistance or consult a professional tradesperson before installation.

- Water lines must be flushed prior to installation
- Do not install if control tubes are damaged in any way
- Control tubes are pressurized after installation. Do not expose tubing to excessive heat, unsealed chemicals, or physical damage
- Use of substitute tubing voids manufacturer warranty and liability
- Do not expose valves to thread sealants/plumbers putty
- Operating Range: 0 - 125 psi (8.6 bar) Max, 140° F (60° C) Max

GENERAL



This illustration shows a typical installation for the Euro Model 1770 series Tapmaster. The valve blocks are connected in-line on the hot and cold water supplies with 3/8" compression fittings. The Euro foot activator is mounted on the cabinet toe kick with the control tubing routed from the foot activator through the cabinet base to the hot and cold water supplies to make the connections to the valve blocks.

Models 1771 and 1776 come with one valve block and are generally used on tepid or single line water supplies. Models 1770 and 1775 come with two valve blocks for standard hot and cold water lines. Installations will vary according to the design of the cabinet, type of faucet and plumbing hardware. In some cases, it may be simpler to connect the valve blocks at a mid-point along the 3/8" supply tubing. In this case it will be necessary to obtain a 3/8" x 3/8" compression connector (available at most hardware stores) to connect the inlet fitting into the water lines. Other plumbing arrangements may be encountered where larger than 3/8" O.D. tube sizes are used. In these situations reducing adapters (available at hardware stores) must be obtained to install the Tapmaster.

Although Tapmaster will work with any faucet, faucets that have handles which give a reference for flow and temperature are recommended. The Euro foot activator will fit cabinets with toe kicks ranging in height from 3" (75mm) to 6" (150mm) and it is recommended to be vertically aligned with the center of the faucet. The plastic probe part of the foot activator is cut to length to keep the bottom of the probe approximately 1/2" to 1" above the floor.

OPERATION

Models 1770 and 1771 feature momentary operation only, while Models 1775 and 1776 incorporate a lock on feature in addition to momentary operation.

To operate the Tapmaster Euro in *momentary mode*, leave the faucet open at the flow and temperature desired, push the Euro probe foot activator in any direction for momentary water flow, release to turn off.

For *continuous mode*, push the Euro probe foot activator sideways to 45 degrees in either direction to lock on; push activator back to vertical rest position to turn off. The locking feature allows the operator to manually use the faucet for such things as filling the sink, etc. It is not recommended for repeated on/off operation. This feature has been intentionally designed to require a deliberate thoughtful motion on the part of the operator to prevent locking inadvertently.

Tapmaster does not alter the appearance of the faucet, therefore a *removable decal* is provided which may be located on any hard smooth surface near the faucet to alert people to its method of operation.

CAUTION: it is possible for pets or small children to inadvertently lock on the Tapmaster—simply leave the faucet closed. **Never** leave the drain stopper in the closed position in any sink.

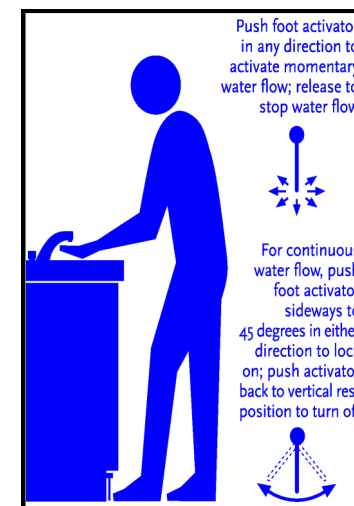

INSTALLING THE EURO PROBE

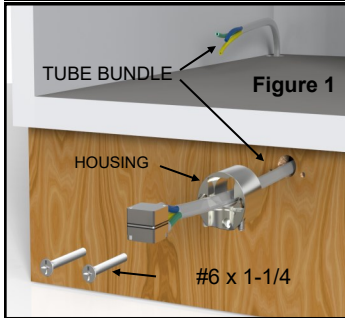

GENERAL: The instructions below for mounting the Euro probe are for a typical installation and only a guideline. Sink/cabinet styles, toe kick heights and construction materials vary greatly. If mounting onto a metal cabinet base the wood mounting screws should be replaced with machine screws with nuts and washers. Be sure to take into account the swing of the locking version of the probe (as illustrated on the next page) placement of mats, typical users etc.

STEP #1 - As in **Figure 1** draw a line on the cabinet toe kick vertically aligned with the center of the faucet/sink. (*NOTE: this is recommended for both right and the left footed users — not a requirement*). Draw a horizontal line approximately 3/4" (19 mm) below the toe

kick overhang (be sure the cabinet door will clear the Euro housing and that this line is level).

STEP #2 - Attach the self-adhesive drilling template label provided to the toe kick by aligning the cross-hairs on the template with the vertical and horizontal line on the toe kick. Drill two pilot holes for #6 screws and drill a 3/8" to 5/8" hole for the control tube bundle as indicated on the template. Drill another hole of similar size in the back of the inside of the cabinet floor. Remove the template.

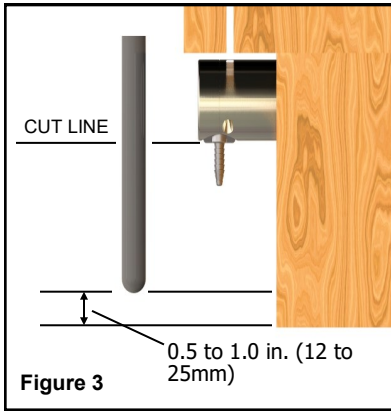

the housing with the 5/64" hex wrench provided.

STEP #5 - As in **Figure 3** place a mark on the probe so its cut length will position its rounded end approximately 1/2 to 1" above the finished floor (*NOTE: height of the probe above the finished floor is a personal preference - 1" clearance is recommended for situations where users are in shoes and to facilitate cleaning, whereas, the lower 1/2" clearance is recommended for situations where users are in bare or stocking feet*).

STEP #6 - As in **Figure 4** use a sharp knife and piece of paper rolled on the probe as a guide to make as square a cut as possible. Push the probe on to the stepped barb of the actuator as far as possible and check for free 360° movement of the probe. On 1775 and 1776 models push the probe to the right and left locked positions (*NOTE: the locking feature is designed for use by the foot and using the hand will seem difficult— this is normal*).

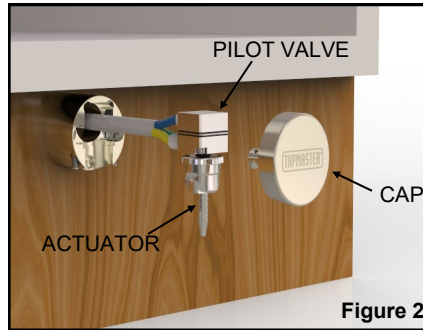

Remove the template.

STEP #3 - Route the control tube bundle through the Euro housing and use a "fish tape", stiff wire (example: coathanger) or other means to pull the control tubing through the holes (see the illustration on page 1). Be sure not to kink the tube bundle. With the two #6 x 1-1/4" long screws provided mount the Euro housing.

STEP #4 - As in **Figure 2** position the actuator and pilot valve simultaneously into the housing. Be sure the black plastic part of the actuator is vertically aligned with the brass button of the valve. Install the cap and tighten the set screws in

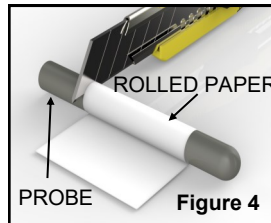

INSTALLING THE VALVE BLOCKS

STEP #1 - Connect the control tubes from the euro actuator to the valve block with the plastic sleeves provided as per the color-coded arrangement in **Figure 5**. To ease installation, dip the ends of the tubing into hot soapy water and, using needle nose pliers, push the tubing on to the barb fittings. An adjustable wrench opened to the diameter of the tubing will assist in pushing on the sleeves. Take care not to damage the barb fittings or crush the tubes. If a tube must be removed from a barb fitting, split the tube with a sharp knife (*Do not pull as this may damage barbs*).

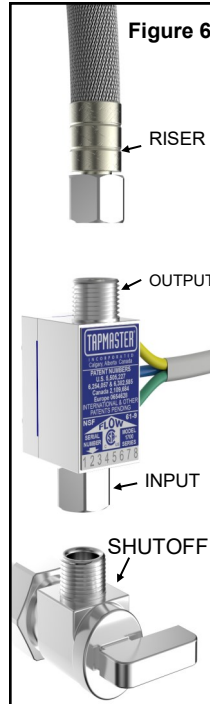
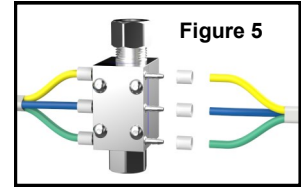

STEP #2 - Turn off the water supplies and place a bucket underneath the shut off valves to catch the water that may run out of the plumbing. (*Closing the faucet handles will minimize leakage*). Loosen the compression nuts on the connecting 3/8" O.D. supply tubes, at the shut off valves. If the faucet utilizes copper tube risers, bend and reposition the tubes in such a manner as to create a 1-1/2" gap (*DO NOT KINK*). To simplify the installation, replace the copper risers with flex risers (available at hardware stores). If this cannot be readily accomplished the tubes will have to be shortened approximately 1-1/2". Cut the tubes with a tube cutter. If a tube cutter is unavailable a hacksaw may be used, however be sure to de-bur and square the ends. Extra compression nuts and sleeves are provided should the tubes need to be cut.

STEP #3 - Prior to installing the valve blocks, open the shut-off valves momentarily to flush out any debris in the water lines. Large pieces of water borne debris will be trapped by the filter/screen in the valve blocks and may reduce water flow or cause noisy operation. As shown in **Figure 5** connect the valve block(s) with the integrated nut (input) to the shutoff fitting and the faucet riser to the compression thread (output). Finger tighten only until both valve blocks are in position. Be sure the plastic control tubing and fittings are not damaged.

STEP #4 - Proceed to tighten the compression nuts using a 5/8" wrench on the nut and a 7/8" wrench on the valve block body. Do not over tighten 3/8" compression fittings with O-ring seals such as the valve block input fitting. Hand tighten plus 1/2 turn with wrench.

STEP #5 - Verify that all connections are tight. Turn on the water supply(s) and inspect all connections for leaks. Set the faucet, both hot and cold, completely open and push the kick plate to activate the water flow. Operate the euro on and off rapidly to clear air from the valves. The valves may exhibit noise until the air is cleared. Re-inspect all connections for leaks.

OPERATION RADIUS OF MOMENTARY/LOCKING EURO ACTIVATORS

