

OPERATION

To operate the Tapmaster simply — (a) press your knee or leg against the cabinet door or (b) press the foot lightly against the kick plate and then set the faucet open to the desired flow and temperature. Once the faucet has been adjusted it should be left open.

To operate the kick plate in *momentary mode*, simply press the foot lightly against the kick plate and open the faucet to the desired flow and temperature. By releasing the kick plate, the Tapmaster shuts off the water flow to the faucet.

For *continuous mode*, press down in the middle of the kick plate angled face until it "latches". This will provide continuous flow to the faucet until the kick plate is tapped again to unlatch. The latching feature allows the operator to manually use the faucet for such things as filling the sink, etc. It is not recommended for repeated on/off operation. This feature has been intentionally designed to require a deliberate thoughtful motion on the part of the operator to prevent latching inadvertently. As in other pedal operated devices, all operators should allow themselves some time to get accustomed to the position and "feel" of this kick plate.

The Tapmaster does not alter the appearance of the faucet, therefore *removable decals* are provided which may be located on any hard smooth surface near the faucet except drywall to alert people to its method of operation.

TROUBLE SHOOTING

Symptom	Possible Cause	Remedy
The hot or cold water is very slow to turn on	Pinched tubing	Check control tubing (yellow and blue lines)
The hot or cold water is very slow to shutoff or will not shutoff	Pinched tubing	Check control tubing (green and blue)
Noise from the Valve Blocks while the water is running	The Valve Block may have excessive debris trapped under the Filter-screen	Service the Valve Blocks
Noise from the Valve Blocks when turning water on and off	Air in the system	Operate the pedal on and off rapidly to clear air from the valves.

For further information: www.tapmaster.ca or call 800-791-8117

FIVE YEAR LIMITED WARRANTY

Congratulations on your purchase of TAPMASTER Hands Free Faucet Controller!

TAPMASTER products are thoroughly tested before shipment and are warranted to be free of defects in material and workmanship for five years from the date of original purchase. The sole obligation of Tapmaster Incorporated under the warranty is to provide replacement parts or at its option to repair the defective product or to provide the replacement product. Replacement parts furnished in fulfillment of this warranty are warranted only for the unused portion of the original warranty. Labor and shipping charges are not included.

Warranty conditions - The five year warranty is subject to exclusions and limitations as stated below:

Warranty extends only to defects which occur during normal use and intended applications and does not extend to damage to products or parts resulting from alteration, repair, modification or faulty installation. This warranty does not cover damage resulting from water borne debris or from media other than clean potable water. Tapmaster Incorporated makes no other express warranty on this product, all implied warranties including any implied warranty of merchantability and fitness for a particular purpose are hereby disclaimed and excluded. In no event shall Tapmaster Incorporated be liable for special, incidental or consequential damages resulting from the use of this product or arising from breach of warranty or contract, negligence, loss of time, inconvenience or loss of use of equipment.

Tapmaster Incorporated
3-1470 28th Street NE
Calgary, AB Canada
T2A 7W6

Rev 3.0
-4-

PH: 800-791-8117
FAX: 403-275-5928
Web: www.tapmaster.ca
E-mail: info@tapmaster.ca



CSA-B125.1-18
ASME A11.18.1-2018
NFS/ANSI 61-2016
NFS/ANSI 372-2016



PATENT NUMBERS
U.S. 5,505,227, 6,254,057,
6,382,585
Canadian 2,109,684
European 0654628
International & Other Patents
Pending

INSTALLATION INSTRUCTIONS: Model 1758

CAUTION - READ BEFORE INSTALLATION

Tapmaster Incorporated will not be held liable for damage to property or persons resulting from improper installation of this product. If you are uncertain about any part of the installation process, please contact us for assistance or consult a professional tradesperson before installation.

- Water lines must be flushed prior to installation
- Do not install if control tubes are damaged in any way
- Control tubes are pressurized after installation. Do not expose tubing to excessive heat, unsealed chemicals, or physical damage
- Use of substitute tubing voids manufacturer warranty and liability
- Do not expose valves to thread sealants/plumbers putty
- Operating Range: 0 - 125 psi (8.6 bar) Max, 140° F (60° C) Max

GENERAL



This illustration shows a typical installation for the Model 1758 Tapmaster. The valve blocks are connected in-line on the hot and cold water supplies with 3/8" O.D. compression fittings. The pilot/actuator valve is mounted about knee height on the inside wall of the cabinet opposite the door hinge. The kick plate is mounted on the cabinet toe kick. The control tubing is routed through the cabinet base to the hot and cold water supplies to make the connections to the valve blocks.

The Model 1758 comes with two valve blocks attached to a pilot/actuator valve and a kick plate. This model is generally used on cabinets that require control from the cabinet door and the toe kick. Installations will vary according to the design of the cabinet, type of faucet and plumbing hardware. In some cases it may be simpler to connect the valve blocks at some convenient mid-point along the 3/8" supply tubing. In this case it will be necessary to obtain a 3/8" x 3/8" compression connector (*available at most hardware stores*) to connect the inlet fitting into the water lines. Other plumbing arrangements may be encountered where larger than 3/8" O.D. tube sizes are used. In these situations reducing adapters (must be obtained to permit installation of the Tapmaster).

Although the Tapmaster will work with any faucet, faucets with handles that give a visual reference for flow and temperature are recommended. Doors with spring loaded hinges are recommended, however mechanical and magnetic latches will work equally well as long as there is some play in the mechanism to accommodate the 1/32" stroke of the pilot/actuator valve. Cabinet toe kicks should allow free access to the kick pedal, particularly the upper angled face to facilitate the latching feature (> 4" in height required).

INSTALLING THE PILOT/ACTUATOR VALVE

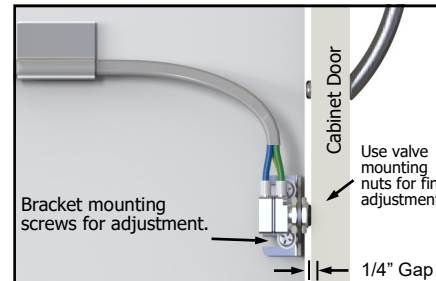

First determine a location where the pilot/actuator valve is to be mounted on the inside of the cabinet opposite the door hinge, at about knee height or higher. The objective is to mount the pilot valve so that the inside face of the cabinet rests against the button of the pilot valve. This will set the door ajar slightly, about 1/32".

STEP #1 - Fasten the mounting bracket with the wood screws and washers provided, ensuring that there is approximately 1/4" gap between the inside of the door and the face of the mounting bracket.

STEP #2 - Mount the pilot/actuator valve onto the mounting bracket ensuring the inside of the door rests against the button of the pilot/actuator valve. To adjust the position of the pilot/actuator valve relative to the door, use the screw slots on the mounting bracket as a coarse adjustment and the hex nuts on the pilot/actuator valve body as a fine adjustment. The pilot/actuator should be positioned to assure full travel of the button of the pilot/actuator valve while minimizing how far the door is set ajar or offset.

STEP #3 - Route the control tubing with the self-adhesive plastic clips provided. The control tubing is pressurized, be sure it is properly secured to prevent accidental damage by cabinet doors, hinges or objects being transferred in and out of the cabinet.

INSTALLING THE KICK PLATE

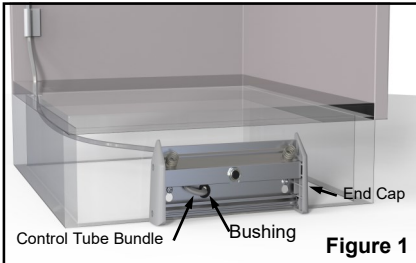

Start by determining whether the control tubing will be routed through the base of the kick plate as in **Figure 1**, or through the kick plate end cap as in **Figure 2**. It is recommended the kick plate be positioned as to be aligned with the center of the faucet/sink.

CONTROL TUBING ROUTED THROUGH KICK PLATE BASE (Figure 1)

STEP #1 - Drill a 1/2" to 2" hole in the cabinet toe kick and similar size hole in the back of the inside of

the cabinet floor. Using a "fish tape", wire or other means, pull the control tubing through the holes. Be sure not to kink the tubing. Before drilling the holes, make sure there are no utilities in behind the cabinet panels which may be damaged.

STEP #2 - Remove the end cap by removing the two screws on the end cap and slide off the cover (They may require tapping or prying to remove).

STEP #3 - Momentarily reassemble the end cap back on the aluminum base. Temporarily remove the control tube bundle and the snap pushing from its hole in the base. Place the assembly against the toe kick. With the end caps resting on the floor and the center of the kick plate assembly aligned with the center of the sink/faucet, mount the kick plate with the two #8 x 3/4" pan head Phillips screws provided.

STEP #4 - Remove the end cap. Slide the cover back on the kick plate base, by pressing down on each spring in succession while the cover is slid on. Remount the end cap.

CONTROL TUBING ROUTED THROUGH PEDAL END CAP (Figure 2)

It is recommended that the control tubing be routed on the inside of the hinge side of the cabinet door.

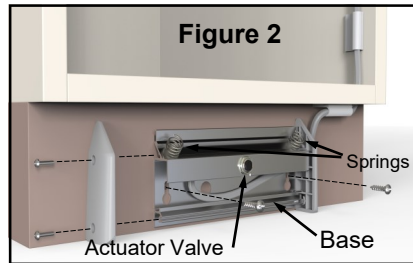

STEP #1 - Remove the end cap which the tubing is to be routed through by removing the two screws on the end cap and slide off the cover (They may require tapping or prying to remove).

STEP #2 - Drill a 5/16" hole through the end cap using the upper of the two cone shaped recesses on the inside of the end cap as a guide (see **Figure 3**).

Repeat **STEP #3** and **STEP #4** as above.

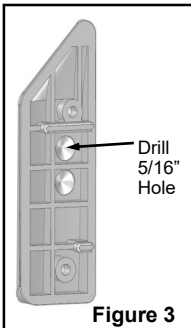

Figure 3

INSTALLING THE VALVE BLOCKS

The Tapmaster valve blocks are connected in-line between the hot and cold shut off valves and the faucet tubes as shown in **Figure 4**. The valve blocks are identical in function and may be used on either hot or cold water lines. Position them according to how the control tubing will be routed.

STEP #1 - Connect the control tubes from the kick plate to the valve block with the plastic sleeves provided as per the color-coded arrangement in **Figure 4**. To ease installation, dip the ends of the tubing into hot soapy water and, using needle nose pliers, push the tubing on to the barb fittings. An adjustable wrench opened to the diameter of the tubing will assist in pushing on the sleeves. Take care not to damage the barb fittings or crush the tubes. If a tube must be removed from a barb fitting, split the tube with a sharp knife (Do not pull as this may damage barbs).

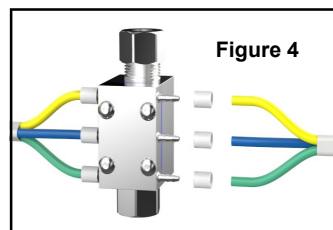
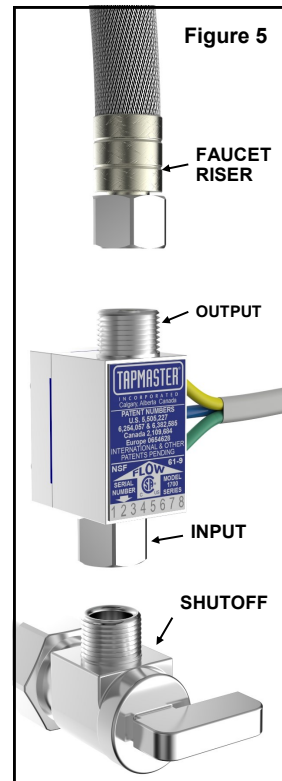

Figure 4



STEP #2 - Turn off the water supplies and place a bucket underneath the shut off valves to catch water that may run out of the plumbing. (Closing the faucet handles will minimize leakage). Loosen the compression nuts on the connecting 3/8" O.D. supply tubes, at the shut off valves. If the faucet utilizes copper tube risers, bend and reposition the tubes in such a manner as to create a 1-1/2" gap (DO NOT KINK). To simplify the installation, replace the copper risers with flex risers (available at hardware stores). If this cannot be readily accomplished the tubes will have to be shortened approximately 1-1/2". Cut the tubes with a tube cutter. If a tube cutter is unavailable a hacksaw may be used, however be sure to de-bur and square the ends. Extra compression nuts and sleeves are provided should the tubes need to be cut.

STEP #3 - Prior to installing the valve blocks, open the shut-off valves momentarily to flush out any debris in the water lines. Large pieces of water borne debris will be trapped by the filter/screen in the valve blocks and may reduce water flow or cause noisy operation. As shown in **Figure 5** connect the valve block(s) with the integrated nut (input) to the shutoff fitting and the faucet riser to the compression thread (output). Finger tighten only until both valve blocks are in position. Be sure the plastic control tubing and fittings are not damaged.

STEP #4 - Proceed to tighten the compression nuts using a 5/8" wrench on the nut and a 7/8" wrench on the valve block body. Do not over tighten 3/8" compression fittings with O-ring seals such as the valve block input fitting. Hand tighten plus 1/2 turn with wrench.

STEP #5 - Verify that all connections are tight. Turn on the water supply(s) and inspect all connections for leaks. Set the faucet, both hot and cold, completely open and push the kick plate to activate the water flow. Operate the kick plate on and off rapidly to clear air from the valves. The valves may exhibit noise until the air is cleared.

ADJUSTING THE KICK PLATE

The kick plate assembly may require adjustment from time to time to compensate for wear in the latching mechanism or simply adjusted to suit personal preference. The latch may be set to operate heavy or sensitive depending upon the position of the pilot/actuator valve in the kick plate base.

STEP #1 - Remove the kick plate assembly from cabinet toe kick and then remove the end cap (To adjust the kick plate properly one should be able to see through the assembly as per **Figure 6**).

STEP #2 - Proceed to adjust the mounting height of the pilot/actuator valve by adjusting the valve body mounting nuts until there is approximately a 0.02" air gap between the black button of the pilot/actuator valve and the inside of the cover. Be sure to hold the hook of the cover against the catch of the base to take up any play (Note: Repositioning the nuts by as little as half a turn is often adequate)

STEP #3 - Test the assembly for proper operation using your hands only. In momentary mode (pressing the vertical face) the cover should move freely and the black button should bottom out before the hook of the cover bottoms against the base. In continuous mode (pressing the angled face) the top of the cover should return to its unlatched position by a firm tap against the bottom vertical face of the cover. If the cover unlatches with difficulty, the gap will need to be increased. If the cover does not latch at all or is too sensitive, decrease the gap. Remount the kick plate to the cabinet toe kick as per instructions above.

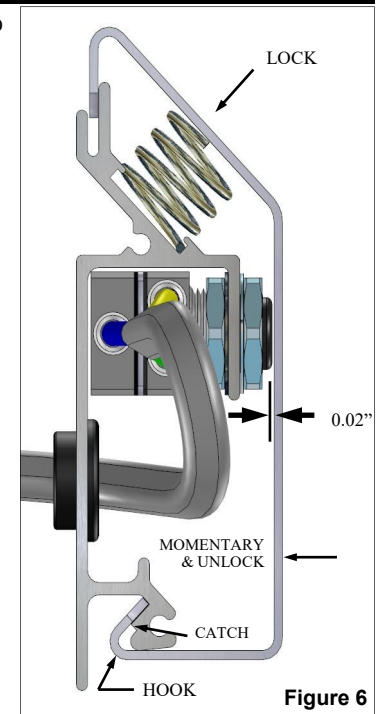

Figure 6